

KNIVES and MAT CUTTERS

**Cutting Mats
Knives & replacement Blades
Matt Cutters
Palette/Painting Knives**

KNIVES & BLADES

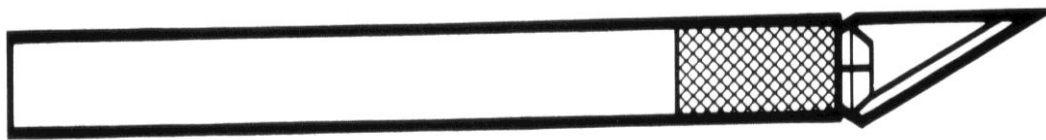

16001

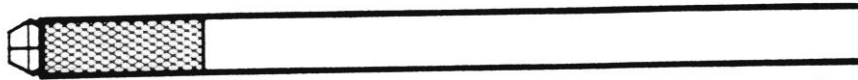
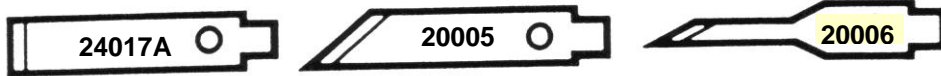

#7 Handle
with Blades
to Suit

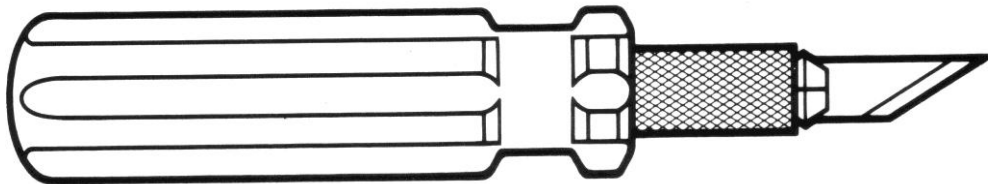

16005

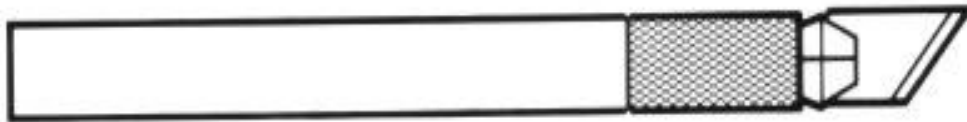

16002



16004

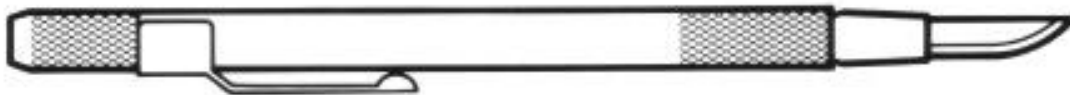

16047



Sparter



NTL500



#180

OLFA knives



A

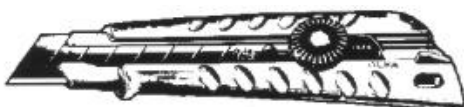

FL



AK1

KNIVES & BLADES

CKS AUTO LOCK CUTTERS



Auto Lock AM230	Small	CT230		each
Heavy Duty	XD	CT116		each

SPARTER



Fixed blade		CT705		each
Retractable blade		CT704		each
Replacement blades	No.92	CT700	5pc	pkt

NT. CUTTERS



Snap off blade				
No. S 200/S202	Small	CT202		each
No. A 300	Small	CT301		each
No. 500L	Large	CT500		each

BLADES

"A"	Fits small knife	CT109	6pc	pkt
"L"	Fits large knife	CT150	5pc	pkt

OLFA Knives

No. 180	Small	CT180		each
Model A	Small	CT113		each
Model L	Large	CT114		each
Art Knife AK1	Yellow handle	CT112		each
P-800 For scoring		CT800		each

BLADES

AB 180, A		CT310	10pc	pkt
LB, Large		CT311	10pc	pkt
AKB Art knife		CT302	25pc	pkt

SCALPEL BLADE HOLDERS

Surgical blade holder	CT802		each
-----------------------	-------	--	------

SWAN MORTON SCALPEL BLADES

Single blades	CT701		each
Carton 100 blades	CT703		box

GRIFHOLD/EXCEL KNIVES (See illustration page 100)

16001	Stencil knife with safety cap	CT451		each
16002	Stencil knife	CT452		each
16005	Heavy duty	CT453		each
30605	Stylus burnisher	CT455		each
16004	Swivel knife	CT456		each
16047	Deluxe Retractableknife	CT457		each
30604	Pin Vise	CT458		each

BLADES (See illustration)

contains 20011		CT459	5pc	pkt
22 - 611		CT460	100pc	box
20064	Swivel	CT464	2pc	pkt
70038	Pin Vise	CT465	2pc	pkt
20019		CT466	5pc	pkt

CIRCLE CUTTERS



NT 1500		CT501		each
Blades for 1500		CT109	2pc	pkt

ROTARY CUTTERS OLFA



RTY 1G	CT128	28mm	each
RTY 2G	CT145	45mm	each
RTY 3G	CT160	60mm	each

CUTTING MATS

PREMIER

Graduated - Self Healing

Green, Opaque

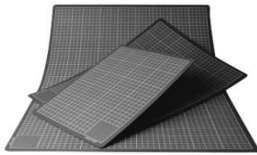

Excellent surface for cutting, sticking, painting or clay work.

- 230x190cm
- 300x220cm
- 450x300cm
- 450x600cm
- 600x900cm

- CT100
- CT102
- CT103
- CT104
- CT105

- each
- each
- each
- each
- each

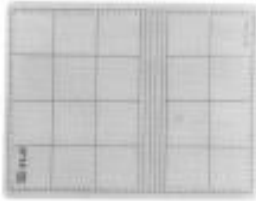

Transparent

Ideal over a Light Box

- 450x300cm
- 450x600cm
- 600x900cm

- CT106
- CT107
- CT108

- each
- each
- each

MAT CUTTERS

LOGAN

Hand Mat Cutters

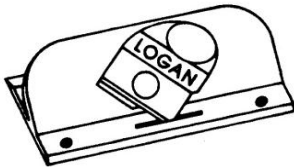

- # 1100
- # 2000
- # 3000
- # 4000

- CT410
- CT220
- CT330
- CT440

- each
- each
- each
- each

SERIES 1100 - Cuts a 45° bevel directly on the scribed pencil line with no offset. Free hand are a snap. Simply draw a design and follow it with the blade. Two depth settings for single and double thickness mat board, eliminate unnecessary drag.

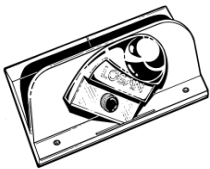

SERIES 2000 - A quality hand-held mat cutter with the select features that make precision mat cutting a breeze. For the artist, student of hobbyist who looks for top quality results with less effort. A retractable blade ensures that the blade enters and leaves the mat board at the correct angle eliminating unsightly hooks. Over cuts can be upgraded, with the addition of nylon bearings to work with Logan Compact and Simplex cutting boards.

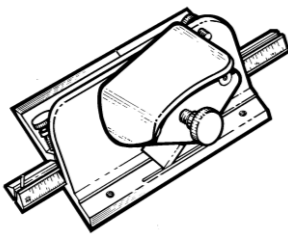

SERIES 4000 - The most advanced hand-held mat cutter for the serious student, artist, free-lancer, photographer or small gallery. The built-in marker system quickly marks the mat for borders from 1/4" to 5.5". The finger tip operated blade holder pivots smoothly assuring accurate entry and retraction of the blade from the mat without curves and hooks. The start and stop line controls over cuts. Designed on the same principle as professional quality mat cutters.

Mat Cutter Blades

CT270

10pc

pkt

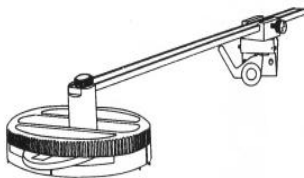

SERIES 201 LOGAN 3-Step Oval & Circle Mat Cutter. Cuts oval sizes from 3"x4.5" to sizes from 3"x4.5" to An exclusive levered stepping mechanism enters the blade into the mat gradually ensuring perfect bevels every time. Handy and portable, the 3-Step can be secured at any location on the mat for multiple openings and can be used in combination with Logan straight line mat cutters to create great creative mats.

3 step Oval Cutter 201

CT205

each

Mat Cutter Kit 301 - Cutter with straight edge

CT333

each

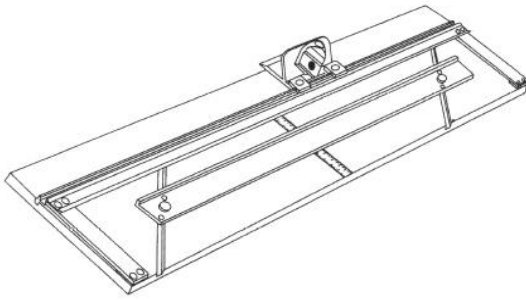

Model #301- Cutting board with bevel-cutting head.

Model #301-S - Cutting board with bevel and straight cutting heads.

SERIES #301 - A remarkable 32" Mat Cutting System that can bevel cut any size mat board. ideal for at home framing projects or the small art studio. A natural for the artists or photographers who present their work in the best possible light - and save money doing it. Framer quality mat cutting with a guided cutting head that runs on a grooved rail. Measuring and marking made simple with a parallel mat guide that can be locked into position on a fully incremental scale. A start and stop line controls over cuts.

ADAPTOR-A-RAIL KITS

CT524

24"

each

CT540

40"

each

CT541

60"

each



Series 524

24" rail with clamp, bearings and screws. For use with Series 2000, 3000 and 4000

Series 540

40" rail with clamp, bearings, and screws. For use with Series 2000, 3000 and 4000

Series 560

60" rail with clamp, bearings and screws. For use with Series 2000, 3000 and 4000

SIMPLEX CUTTER

Model 700 or 750

CT750

each

Model 760SG

CT760

each

THE LOGAN SIMPLEX MAT CUTTER

Designed with professional features for professional results, the Logan Simplex Mat Cutter is the lowest cost, easiest to use full featured mat cutter ever manufactured. Ideal for artists, photographers and professional framers, the Simplex provides superior results time after time.

MODEL 700SGM

Complete 40.5" system with squaring angle, measuring stops, mat guide plus bevel and straights heads.

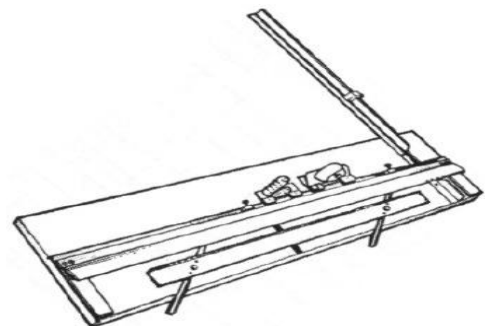

MODEL 760SG

60.5" system with squaring angle, measuring stops plus bevel and straight cutting heads.

40.5" = 102cm

60.5" = 163cm

PALETTE KNIVES

(As Illustrated on page 105)

PREMIER	100mm		50/3	PT325	each
	60mm		50/4	PT324	each
	65mm		50/7	PT323	each
	80mm	Cranked	50/5	PT328	each
	110mm		50/2	PT322	each

PAINTING KNIVES

PREMIER

(as illustrated on Page 104)

2800	PT300	2902	PT301	2910	PT302	2913	PT303	
2914	PT304	2920	PT305	2922	PT306	2930	PT307	
2935	PT309	2951	PT310	2952	PT311	2953	PT312	
2960	PT313	2990	PT315	2932	PT308	2970	PT314	each

PLASTIC PAINTING KNIVES

SET OF 5 ASSORTED SHAPES - PLASTIC

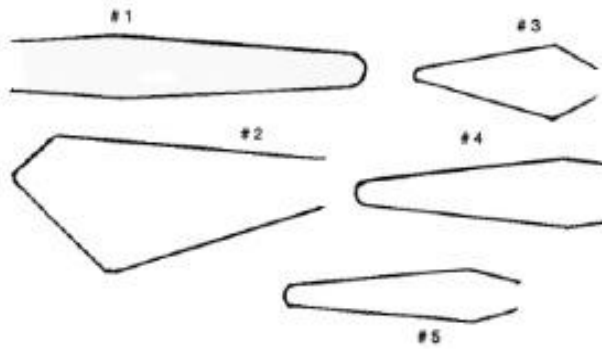

Assorted PT331 5pc set

Painting Knives actual size as illustrated

